

## Summarized from

Hobbes' Internet Timeline v4.2 by Robert H'obbes' Zakon  
<http://info.isoc.org/guest/zakon/Internet/History/HIT.html>

and  
 The Roads and Crossroads of Internet History by Gregory R. Gromov  
<http://www.netvalley.com/netvalley/intval.html>

and  
 History of the Internet: <http://www.internetvalley.com/archives/mirrors/davemarsh-timeline-1.htm>

[ 1950s ] [ 1960s ] [ 1970s ] [ 1980s ] [ 1990s ] [ Growth ] [ FAQ ] [ Sources ]

**Hobbes' Internet Timeline Copyright (c)1993-9 by Robert H Zakon.** Permission is granted for use of this document in whole or in part for non-commercial purposes as long as this Copyright notice and a link to this document, at the archive listed at the end, is included. A copy of the material the Timeline appears in is requested. For commercial uses, please contact the author first. Links to this document are welcome after e-mailing the author with the document URL where the link will appear.

The author wishes to acknowledge the [Internet Society](#) for hosting this document, and the many Net folks who have contributed suggestions and helped with the author's genealogy search.

1836 -- Telegraph. Cooke and Wheatstone patent it.

Revolutionised human (tele)communications.

Morse Code a series of dots and dashes used to communicate between humans. This is not a million miles away from how computers communicate via (binary 0/1) data today. Although it is much slower!

1858-1866 --

The [Atlantic cable](#) of 1858 was established to carry instantaneous communications across the ocean for the first time: it was a technical failure. It only remained in service a few days.

Subsequent cables laid in [1866](#) were completely successful and compare to events like the moon landing of a century later. ... the cable ... remained in use for almost 100 years.

Transatlantic cable. Allowed direct instantaneous communication across the atlantic.

Today, cables connect all continents and are still a main hub of telecommunications.

1876 -- Telephone. Alexander Graham Bell Exhibits.

Telephones exchanges provide the backbone of Internet connections today.

Modems provide Digital to Audio conversions to allow computers to connect over the telephone network.

## 1950s

1957

USSR launches Sputnik, first artificial earth satellite. In response, US (Eisenhower) forms the Advanced Research Projects Agency ([ARPA](#)) within the Department of Defense (DoD) to establish US lead in science and technology applicable to the military (:amk:)

The organization united some of America's most brilliant people, who developed the United States' first successful satellite in 18 months. Several years later ARPA began to focus on computer networking and communications technology.

## 1960s

1961

Leonard Kleinrock, MIT: "Information Flow in Large Communication Nets" (July)

- First paper on **packet-switching** (PS) theory  
***Packet-switching (PS) networks developed; Why is this relevant?***

***As we will see later the Internet relies on packets to transfer data.***

***The origin is military : for utmost security in transferring info of networks (no single outage point).***

***Data is split into tiny packets that may take different routes to dest.***

***Hard to eavesdrop on messages. More than one route available -- if one route goes down another may be followed.***

***Networks can withstand large scale destruction***

***(Nuclear attack - This was the time of the Cold War).***

1962

J.C.R. Licklider & W. Clark, MIT: "On-Line Man Computer Communication" (August)

- *Galactic Network* concept encompassing distributed social interactions

***Dr. J.C.R. Licklider was chosen to head ARPA's research in improving the military's use of computer technology. Licklider was a visionary who sought to***

*make the government's use of computers more interactive. To quickly expand technology, Licklider saw the need to move ARPA's contracts from the private sector to universities and laid the foundations for what would become the ARPANET.*

#### 1964

Paul Baran, RAND: "On Distributed Communications Networks"

- Packet-switching networks; no single outage point

#### 1965

ARPA sponsors study on "cooperative network of time-sharing computers"

- TX-2 at MIT Lincoln Lab and AN/FSQ-32 at System Development Corporation (Santa Monica, CA) are directly linked (without packet switches) via a dedicated 1200bps phone line; Digital Equipment Corporation (DEC) computer at ARPA later added to form "The Experimental Network"

#### 1966

Lawrence G. Roberts, MIT: "Towards a Cooperative Network of Time-Shared Computers" (October)

- First ARPANET plan

#### 1967

ARPANET design discussions held by Larry Roberts at ARPA IPTO PI meeting in Ann Arbor, Michigan (April)

ACM Symposium on Operating Principles in Gatlinburg, Tennessee (Oct.)

- First design paper on ARPANET published by Larry Roberts: "Multiple Computer Networks and Intercomputer Communication"
- First meeting of the three independent packet network teams (RAND, NPL, ARPA)

National Physical Laboratory (NPL) in Middlesex, England develops NPL Data Network under Donald Watts Davies who coins the term packet. The NPL network, an experiment in packet-switching, used 768kbps lines

It happened that the work at MIT (1961-1967), at RAND (1962-1965), and at NPL (1964-1967) had all proceeded in parallel without any of the researchers knowing about the other work.

#### 1968

>PS-network presented to the Advanced Research Projects Agency (ARPA)

>Request for proposals for ARPANET sent out in August; responses received in September

>University of California Los Angeles (UCLA) awarded Network Measurement Center contract in October

>Bolt Beranek and Newman, Inc. (BBN) awarded Packet Switch contract to build **Interface Message Processors** (IMPs)

>US Senator Edward Kennedy sends a congratulatory telegram to BBN for its million-dollar ARPA contract to build the "Interfaith" Message Processor, and thanking them for their ecumenical efforts

>Network Working Group (NWG), headed by Steve Crocker, loosely organized to develop host level protocols for communication over the ARPANET.

>The Computer as a Communication Device by J.C.R. Licklider, Robert W. Taylor, Science and Technology, April 1968. Online republish by Systems Research Center of DEC, p.29 ( <ftp://ftp.digital.com/pub/DEC/SRC/research-reports/SRC-061.pdf> )

#### 1969 -- **Birth of Internet (October 29)**

ARPANET commissioned by DoD for research into networking

Nodes are stood up as BBN builds each IMP [Honeywell DDP-516 mini computer with 12K of memory]; AT&T provides 50kbps lines

Node 1: UCLA (30 August, hooked up 2 September)

- *Function*: Network Measurement Center
- *System, OS*: SDS SIGMA 7, SEX
- Node 2: Stanford Research Institute (SRI) (1 October)
- Network Information Center (NIC)
- SDS940/Genie
- Doug Engelbart's project on "Augmentation of Human Intellect"
- Node 3: University of California Santa Barbara (UCSB) (1 November)
- Culler-Fried Interactive Mathematics
- IBM 360/75, OS/MVT
- Node 4: University of Utah (December)

- Graphics
- DEC PDP-10, Tenex
  - First Request for Comment (RFC1): "Host Software" by Steve Crocker (7 April)
  - RFC 4: Network Timetable
  - First packets sent by Charley Kline at UCLA as he tried logging into SRI. The first attempt resulted in the system crashing as the letter G of LOGIN was entered. (October 20 or 29 - being verified)
  - Univ of Michigan, Michigan State and Wayne State Univ establish X.25-based Merit network for students, faculty, alumni (:sw1:)

1969: The first **LOGs**: UCLA -- Stanford

The plan was unprecedented: Kleinrock, a pioneering computer science professor at UCLA, and his small group of graduate students hoped to log onto the Stanford computer and try to send it some data. They would start by typing "login," and seeing if the letters appeared on the far-off monitor.

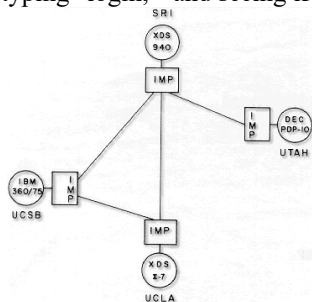

We set up a telephone connection between us and the guys at SRI..." Kleinrock ... said in an interview: "We typed the L and we asked on the phone,

"Do you see the L?"

"Yes, we see the L," came the response.

"We typed the O, and we asked,

"Do you see the O."

"Yes, we see the O."

"Then we typed the G, and the system crashed"...

Yet a revolution had begun"...

1970s

1970

First publication of the original ARPANET Host-Host protocol: C.S. Carr, S. Crocker, V.G. Cerf. "HOST-HOST Communication Protocol in the ARPA Network," in AFIPS Proceedings of SJCC

First report on ARPANET at AFIPS: "Computer Network Development to Achieve Resource Sharing" (March: see [future section](#), does "the future come?")

ALOHAnet, the first packet radio network, developed by Norman Abramson, Univ of Hawaii, becomes operational (July)

- connected to the ARPANET in 1972

ARPANET hosts start using Network Control Protocol (NCP), first host-to-host protocol

First cross-country link installed by AT&T between UCLA and BBN at 56kbps. This line is later replaced by another between BBN and RAND. A second line is added between MIT and Utah

1971

15 nodes (23 hosts): UCLA, SRI, UCSB, Univ of Utah, BBN, MIT, RAND, SDC, Harvard, Lincoln Lab, Stanford, UIU(C), CWRU, CMU, NASA/Ames

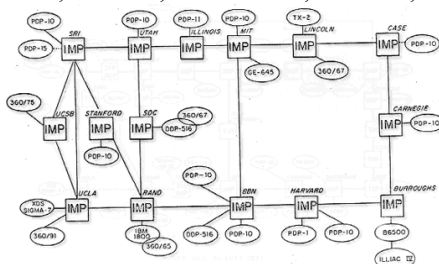

BBN starts building IMPs using the cheaper Honeywell 316. IMPs however are limited to 4 host connections, and so BBN develops a terminal IMP (TIP)

are limited to 4 host connections, and so BBN develops a terminal IMP (TIP) that supports up to 64 hosts (September)

Ray Tomlinson of BBN invents **email** program to send messages across a distributed network. The original program was derived from two others: an intra-machine email program (SENDMSG) and an experimental file transfer program (CPYNET) (:amk:irh:)

## 1972

\*\*\*Ray Tomlinson (BBN) modifies email program for ARPANET where it becomes a quick hit. The @ sign was chosen from the punctuation keys on Tomlinson's Model 33 Teletype for its "at" meaning (March)

\*\*\*Larry Roberts writes first email management program (RD) to list, selectively read, file, forward, and respond to messages (July)

\*\*\*International Conference on Computer Communications (ICCC) at the Washington D.C. Hilton with demonstration of ARPANET between 40 machines and the Terminal Interface Processor (TIP) organized by Bob Kahn. (October)

\*\*\*First **computer-to-computer chat** takes place during ICCC as psychotic PARRY (at Stanford) discusses its problems with the Doctor (at BBN)

\*\*\*International Network Working Group (INWG) formed in October as a result of a meeting at ICCC identifying the need for a combined effort in advancing networking technologies. Vint Cerf appointed first Chair. By 1974, INWG became **IFIP** WG 6.1 (:vgc:)

Louis Pouzin leads the French effort to build its own ARPANET - CYCLADES

RFC 318: Telnet specification

## 1973

\*\*\*First **international connections** to the ARPANET: University College of London (England) and **NORSAR** (Norway)

\*\*\*Bob Metcalfe's Harvard PhD Thesis outlines idea for **Ethernet**. The concept was tested on Xerox PARC's Alto computers, and the first Ethernet network called the Alto Aloha System (May) (:amk:)

\*\*\*Bob Kahn poses Internet problem, starts internetting research program at ARPA. Vinton Cerf sketches **gateway architecture** in March on back of envelope in a San Francisco hotel lobby (:vgc:)

\*\*\*Cerf and Kahn present basic Internet ideas at INWG in September at Univ of Sussex, Brighton, UK (:vgc:)

RFC 454: File Transfer specification

\*\*\*Network Voice Protocol (NVP) specification (RFC 741) and implementation enabling conference calls over ARPANet. (:bb1:)

\*\*\*SRI (NIC) begins publishing ARPANET News in March; number of ARPANET users estimated at 2,000

\*\*\***ARPA study shows email composing 75% of all ARPANET traffic**  
Christmas Day Lockup - Harvard IMP hardware problem leads it to broadcast zero-length hops to any ARPANET destination, causing all other IMPs to send their traffic to Harvard (25 December)

\*\*\*RFC 527: ARPAWOCKY

\*\*\*RFC 602: The Stockings Were Hung by the Chimney with Care

## 1974

\*\*\*Vint Cerf and Bob Kahn publish "A Protocol for Packet Network Interconnection" which specified in detail the design of a Transmission Control Program (**TCP**). [IEEE Trans Comm]

\*\*\*BBN opens **Telenet**, the first public packet data service (a commercial

---

version of ARPANET)

## 1975

\*\*\*Operational management of Internet transferred to DCA (now [DISA](#))

---

\*\*\*[First ARPANET mailing list](#), MsgGroup, is created by Steve Walker. Einar Stefferud soon took over as moderator as the list was not automated at first. A science fiction list, SF-Lovers, was to become the most popular unofficial list in the early days

---

\*\*\*John Vittal develops MSG, the first all-inclusive email program providing replying, forwarding, and filing capabilities.

---

\*\*\*Satellite links cross two oceans (to Hawaii and UK) as the first TCP tests are run over them by Stanford, BBN, and UCL

---

\*\*\*"[Jargon File](#)", by Raphael Finkel at SAIL, first released  
[http://en.wikipedia.org/wiki/Jargon\\_File](http://en.wikipedia.org/wiki/Jargon_File)

## 1976

\*\*\*Elizabeth II, Queen of the United Kingdom sends out an email in February from the Royal Signals and Radar Establishment (RSRE) in Malvern

---

\*\*\*UUCP (Unix-to-Unix CoPy) developed at AT&T Bell Labs and distributed with [UNIX](#) one year later.

---

\*\*\*Multiprocessing Pluribus IMPs are deployed

## 1977

\*\*\*THEORYNET created by Larry Landweber at Univ of Wisconsin providing electronic mail to over 100 researchers in computer science (using a locally developed email system over TELENET)

---

\*\*\*RFC 733: [Mail specification](#)

---

\*\*\*Tymshare launches Tymnet

---

\*\*\*First demonstration of ARPANET/SF Bay Packet Radio Net/Atlantic SATNET operation of Internet protocols with BBN-supplied gateways in July

## 1978

\*\*\*TCP split into TCP and IP (March)

---

\*\*\*RFC 748: [TELNET RANDOMLY-LOSE Option](#)

## 1979

\*\*\*Meeting between U. of Wisconsin, DARPA, [National Science Foundation](#) (NSF), and computer scientists from many universities to establish a Computer Science Department research computer network (organized by Larry Landweber).

---

\*\*\*USENET established using UUCP between Duke and UNC by Tom Truscott, Jim Ellis, and Steve Bellovin. All original groups were under net.\* hierarchy.

---

\*\*\*First MUD, MUD1, by Richard Bartle and Roy Trubshaw at U of Essex

---

\*\*\*ARPA establishes the Internet Configuration Control Board (ICCB)

---

\*\*\*Packet Radio Network (PRNET) experiment starts with DARPA funding. Most communications take place between mobile vans. ARPANET connection via SRI.

---

\*\*\*On April 12, Kevin MacKenzie emails the MsgGroup a suggestion of adding some emotion back into the dry text medium of email, such as -) for indicating a sentence was tongue-in-cheek. Though flamed by many at the time, [emoticons](#) became widely used

---

1980s

## 1980

ARPANET grinds to a complete halt on 27 October because of an accidentally-propagated status-message [virus](#)

First C/30-based IMP at BBN

## 1981

BITNET, the "Because It's Time NETwork"

- Started as a cooperative network at the City University of New York, with the first connection to Yale
- Original acronym stood for 'There' instead of 'Time' in reference to the free NJE protocols provided with the IBM systems
- Provides electronic mail and listserv servers to distribute information, as well as file transfers

---

\*\*\*CSNET (Computer Science NETwork) built by a collaboration of computer scientists and Univ of Delaware, Purdue Univ, Univ of Wisconsin, RAND Corporation and BBN through seed money granted by NSF to provide networking services (especially email) to university scientists with no access to ARPANET.

RFC 801: NCP/TCP Transition Plan

## 1982

Norway leaves network to become an Internet connection via TCP/IP over SATNET; UCL follows suit

---

DCA and ARPA establish the Transmission Control Protocol (TCP) and Internet Protocol (IP), as the protocol suite, commonly known as TCP/IP, for ARPANET.

- This leads to one of the first definitions of an "internet" as a connected set of networks, specifically those using TCP/IP, and "Internet" as connected TCP/IP internets.
- DoD declares TCP/IP suite to be standard for DoD

---

EUnet (European UNIX Network) is created by EUUG to provide email and USENET services.

- original connections between the Netherlands, Denmark, Sweden, and UK

---

Exterior Gateway Protocol (RFC 827) specification. EGP is used for gateways between networks.

## 1983

\*\*\*Name server developed at Univ of Wisconsin, no longer requiring users to know the exact path to other systems

---

\*\*\*Cutover from NCP to TCP/IP (1 January)

---

\*\*\*No more Honeywell or Pluribus IMPs; TIPs replaced by TACs (terminal access controller)

---

\*\*\*Movement Information Net (MINET) started early in the year in Europe, connected to Internet in Sept

---

\*\*\*CSNET / ARPANET gateway put in place

---

\*\*\*ARPANET split into ARPANET and MILNET; the latter became integrated with the Defense Data Network created the previous year. 68 of the 113 existing nodes went to MILNET

---

\*\*\*Desktop workstations come into being, many with Berkeley UNIX (4.2 BSD) which includes IP networking software

---

\*\*\*Networking needs switch from having a single, large time sharing computer connected to the Internet at each site, to instead connecting entire local networks

---

\*\*\*Internet Activities Board (IAB) established, replacing ICCB

---

\*\*\*EARN (European Academic and Research Network) established. Very similar to the way BITNET works with a gateway funded by IBM

---

\*\*\*FidoNet developed by Tom Jennings

## 1984

Domain Name System (DNS) introduced

Number of hosts breaks 1.000

---

JUNET (Japan Unix Network) established using UUCP

---

JANET (Joint Academic Network) established in the UK using the Coloured Book protocols; previously SERCnet

Moderated newsgroups introduced on USENET (mod.\*)

Canada begins a one-year effort to network its universities. The NetNorth Network is connected to BITNET in Ithaca from Toronto

---

Kremvax message announcing USSR connectivity to USENET

## 1985

Information Sciences Institute (ISI) at USC is given responsibility for DNS root management by DCA, and SRI for DNS NIC registrations

---

Symbolics.com is assigned on 15 March to become the first registered domain.

Other firsts: cmu.edu, purdue.edu, rice.edu, ucla.edu (April); css.gov (June);

mitre.org, .uk (July)

---

100 years to the day of the last spike being driven on the cross-Canada railroad, the last Canadian university is connected to NetNorth in a one year effort to have coast-to-coast connectivity. (:kfl:)

---

RFC 968: 'Twas the Night Before Start-up

## 1986

>> NSFNET created (backbone speed of 56Kbps)

- NSF establishes 5 super-computing centers to provide high-computing power for all (JVNC@Princeton, PSC@Pittsburgh, SDSC@UCSD, NCSA@UIUC, Theory Center@Cornell).
  - This allows an explosion of connections, especially from universities.
- 

>> NSF-funded SDSCNET, JVNCNET, SURANET, and NYSERNET operational (:sw1:)

---

>> Internet Engineering Task Force (IETF) and Internet Research Task Force (IRTF) comes into existence under the IAB. First IETF meeting held in January at Linkabit in San Diego

---

>> The first Freenet (Cleveland) comes on-line 16 July under the auspices of the Society for Public Access Computing (SoPAC). Later Freenet program management assumed by the National Public Telecomputing Network (NPTN) in 1989 (:sk2,rab:)

---

>> Network News Transfer Protocol (NNTP) designed to enhance Usenet news performance over TCP/IP.

---

>> Mail Exchanger (MX) records developed by Craig Partridge allow non-IP network hosts to have domain addresses.

The great USENET name change; moderated newsgroups changed in 1987.

---

>> BARRNET (Bay Area Regional Research Network) established using high speed links. Operational in 1987.

---

>> New England gets cut off from the Net as AT&T suffers a fiber optics cable break between Newark/NJ and White Plains/NY. Yes, all seven New England ARPANET trunk lines were in the one severed cable. Outage took place between 1:11 and 12:11 EST on 12 December

## 1987

NSF signs a cooperative agreement to manage the NSFNET backbone with Merit Network, Inc. (IBM and MCI involvement was through an agreement with Merit). Merit, IBM, and MCI later founded ANS.

---

UUNET is founded with Usenix funds to provide commercial UUCP and Usenet access. Originally an experiment by Rick Adams and Mike O'Dell

---

Email link established between Germany and China using CSNET protocols,

with the first message from China sent on 20 September.

---

1000th RFC: "Request For Comments reference guide"

---

Number of hosts breaks 10,000

---

Number of BITNET hosts breaks 1,000

## 1988

>> 2 November - Internet worm burrows through the Net, affecting ~6,000 of the 60,000 hosts on the Internet

---

>> CERT (Computer Emergency Response Team) formed by DARPA in response to the needs exhibited during the Morris worm incident. The worm is the only advisory issued this year.

---

>> DoD chooses to adopt OSI and sees use of TCP/IP as an interim. US Government OSI Profile (GOSIP) defines the set of protocols to be supported by Government purchased products

---

>> Los Nettos network created with no federal funding, instead supported by regional members (founding: Caltech, TIS, UCLA, USC, ISI).

---

>> NSFNET backbone upgraded to **T1 (1.544Mbps)**

---

>> CERFnet (California Education and Research Federation network) founded by Susan Estrada.

---

>> **Internet Assigned Numbers Authority (IANA)** established in December with Jon Postel as its Director. Postel was also the RFC Editor and US Domain registrar for many years.

---

>> Internet Relay Chat (IRC) developed by Jarkko Oikarinen

---

>> First Canadian regionals join NSFNET: ONet via Cornell, RISQ via Princeton, BCnet via Univ of Washington

---

>> FidoNet gets connected to the Net, enabling the exchange of email and news

---

>> The first multicast tunnel is established between Stanford and BBN in the Summer of 1988.

---

**Countries connecting to NSFNET**: Canada (CA), Denmark (DK), Finland (FI), France (FR), Iceland (IS), Norway (NO), Sweden (SE)

## 1989

>> Number of hosts breaks 100,000

---

>> RIPE (Reseaux IP Europeens) formed (by European service providers) to ensure the necessary administrative and technical coordination to allow the operation of the pan-European IP Network.

---

>> First relays between a commercial electronic mail carrier and the Internet: MCI Mail through the Corporation for the National Research Initiative (CNRI), and CompuServe through Ohio State U.

---

>> Corporation for Research and Education Networking (CREN) is formed by merging CSNET into BITNET (August)

---

>> AARNET - Australian Academic Research Network - set up by AVCC and CSIRO; introduced into service the following year

---

>> **Cuckoo's Egg** by Clifford Stoll tells the real-life tale of a German cracker group who infiltrated numerous US facilities

---

>> UCLA sponsors the Act One symposium to celebrate ARPANET's 20th anniversary and its decommissioning (August)

---

RFC 1121: Act One - The Poems

---



RFC 1097: TELNET SUBLIMINAL-MESSAGE Option

**Countries connecting to NSFNET:** Australia (AU), Germany (DE), Israel (IL), Italy (IT), Japan (JP), Mexico (MX), Netherlands (NL), New Zealand (NZ), Puerto Rico (PR), United Kingdom (UK)

1990s

**1990**

>> ARPANET ceases to exist

>> Archie released by Peter Deutsch, Alan Emtage, and Bill Heelan at McGill

>> The World comes on-line (world.std.com), becoming the first commercial provider of Internet dial-up access

>> ISO Development Environment (ISODE) developed to provide an approach for OSI migration for the DoD. ISODE software allows OSI application to operate over TCP/IP

>> CA\*net formed by 10 regional networks as national Canadian backbone with direct connection to NSFNET

>> The first remotely operated machine to be hooked up to the Internet, the Internet Toaster by John Romkey, (controlled via SNMP) makes its debut at Interop. Pictures: Internode, Invisible

RFC 1149: A Standard for the Transmission of IP Datagrams on Avian Carriers

RFC 1178: Choosing a Name for Your Computer

**Countries connecting to NSFNET:** Argentina (AR), Austria (AT), Belgium (BE), Brazil (BR), Chile (CL), Greece (GR), India (IN), Ireland (IE), Korea (KR), Spain (ES), Switzerland (CH)

**1991**

>> Commercial Internet eXchange (CIX) Association, Inc. formed by General Atomics (CERFnet), Performance Systems International, Inc. (PSInet), and UUNET Technologies, Inc. (AlterNet), after NSF lifts restrictions on the commercial use of the Net (March)

>> Wide Area Information Servers (WAIS), invented by Brewster Kahle, released by Thinking Machines Corporation

>> Gopher released by Paul Lindner and Mark P. McCahill from the Univ of Minnesota

>> World-Wide Web (WWW) released by CERN; Tim Berners-Lee developer

>> PGP (Pretty Good Privacy) released by Philip Zimmerman

>> US High Performance Computing Act (Gore 1) establishes the National Research and Education Network (NREN)

>> NSFNET backbone upgraded to **T3 (44.736Mbps)**  
NSFNET traffic passes 1 trillion bytes/month and 10 billion packets/month

>> Defense Data Network NIC contract awarded by DISA to Government Systems Inc. who takes over from SRI in May

>> Start of JANET IP Service (JIPS) which signalled the changeover from Coloured Book software to TCP/IP within the UK academic network. IP was initially 'tunneled' within X.25. (:gst:)

RFC 1216: Gigabit Network Economics and Paradigm Shifts

RFC 1217: Memo from the Consortium for Slow Commotion Research

(CSCR)

**Countries connecting to NSFNET:** Croatia (HR), Czech Republic (CZ), Hong Kong (HK), Hungary (HU), Poland (PL), Portugal (PT), Singapore (SG), South Africa (ZA), **Taiwan** (TW), Tunisia (TN)

**1992**

>> Internet Society (ISOC) is chartered (January)

>> IAB reconstituted as the Internet Architecture Board, becomes part of Internet Society

Number of hosts breaks 1,000,000

First MBONE audio multicast (March) and video multicast (November)

**RIPE** Network Coordination Center (NCC) created in April to provide address registration and coordination services to the European Internet community (:dk1:)

>> Veronica, a gopherspace search tool, is released by Univ of Nevada

>> **World Bank** comes on-line

>> The term "**surfing the Internet**" is coined by Jean Armour Polly (:jap:)

>> **Zen and the Art of the Internet** is published by Brendan Kehoe (:jap:)

>> Internet Hunt started by Rick Gates

RFC 1300: **Remembrances of Things Past**

RFC 1313: **Today's Programming for KRFC AM 1313 - Internet Talk Radio**

**Countries connecting to NSFNET:** Antarctica (AQ), Cameroon (CM), Cyprus (CY), Ecuador (EC), Estonia (EE), Kuwait (KW), Latvia (LV), Luxembourg (LU), Malaysia (MY), Slovakia (SK), Slovenia (SI), Thailand (TH), Venezuela (VE)

**1993**

>> **InterNIC** created by NSF to provide specific Internet services:

- . directory and database services (AT&T)
- . registration services (Network Solutions Inc.)
- . information services (General Atomics/CERFnet)

>> US White House comes on-line (<http://www.whitehouse.gov/>):

- . President Bill Clinton: president@whitehouse.gov
- . Vice-President Al Gore: vice-president@whitehouse.gov

>> Worms of a new kind find their way around the Net - WWW Worms (W4), joined by Spiders, Wanderers, Crawlers, and Snakes ...

>> Internet Talk Radio begins broadcasting (:sk2:)

>> **United Nations** (UN) comes on-line (:vgc:)

>> US National Information Infrastructure Act Businesses and media begin taking notice of the Internet

>> InterCon International KK (IIKK) provides Japan's first commercial Internet connection in September. TWICS, though an IIKK leased line, begins offering dial-up accounts the following month

>> Mosaic takes the Internet by storm; WWW proliferates at a 341,634% annual growth rate of service traffic. Gopher's growth is 997%.

RFC 1437: **The Extension of MIME Content-Types to a New Medium**

RFC 1438: **IETF Statements of Boredom (SOBs)**

---

**Countries connecting to NSFNET:** Bulgaria (BG), Costa Rica (CR), Egypt (EG), Fiji (FJ), Ghana (GH), Guam (GU), Indonesia (ID), Kazakhstan (KZ), Kenya (KE), Liechtenstein (LI), Peru (PE), Romania (RO), Russian Federation (RU), Turkey (TR), Ukraine (UA), UAE (AE), US Virgin Islands (VI)

---

## 1994

>> ARPANET/Internet celebrates 25th anniversary

---

>> Communities begin to be wired up directly to the Internet (Lexington and Cambridge, Mass., USA)

---

>> US Senate and House provide information servers

---

>> Shopping malls arrive on the Internet

---

>> First cyberstation, RT-FM, broadcasts from Interop in Las Vegas

---

>> The National Institute for Standards and Technology (NIST) suggests that GOSIP should incorporate TCP/IP and drop the "OSI-only" requirement (:gck:)

---

>> Arizona law firm of Canter & Siegel "spams" the Internet with email advertising green card lottery services; Net citizens flame back

---

>> NSFNET traffic passes 10 trillion bytes/month

---

>> Yes, it's true - you can now order pizza from the Hut online

---

>> WWW edges out telnet to become 2nd most popular service on the Net (behind ftp-data) based on % of packets and bytes traffic distribution on NSFNET

---

>> Japanese Prime Minister on-line (<http://www.kantei.go.jp/>)

---

>> UK's HM Treasury on-line (<http://www.hm-treasury.gov.uk/>)

---

>> New Zealand's Info Tech Prime Minister on-line (<http://www.govt.nz/>)

---

>> First Virtual, the first cyberbank, open up for business

---

>> Radio stations start rockin' (rebroadcasting) round the clock on the Net: WXYC at Univ of NC, WJHK at Univ of KS-Lawrence, KUGS at Western WA Univ

---

>> Trans-European Research and Education Network Association (TERENA) is formed by the merger of RARE and EARN, with representatives from 38 countries as well as CERN and ECMWF. TERENA's aim is to "promote and participate in the development of a high quality international information and telecommunications infrastructure for the benefit of research and education" (October)

---

>> After noticing that many network software vendors used domain.com in their documentation examples, Bill Woodcock and Jon Postel register the domain. Sure enough, after looking at the domain access logs, it was evident that many users were using the example domain in configuring their applications.

---

RFC 1605: SONET to Sonnet Translation

---

RFC 1606: A Historical Perspective On The Usage Of IP Version 9

---

RFC 1607: A VIEW FROM THE 21ST CENTURY

---

**Countries connecting to NSFNET:** Algeria (DZ), Armenia (AM), Bermuda (BM), Burkina Faso (BF), China (CN), Colombia (CO), Jamaica (JM), Jordan (JO), Lebanon (LB), Lithuania (LT), Macau (MO), Morocco (MA), New Caledonia, Nicaragua (NI), Niger (NF), Panama (PA), Philippines (PH)

Senegal (SN), Sri Lanka (LK), Swaziland (SZ), Uruguay (UY), Uzbekistan (UZ)  
 >> Top 10 Domains by Host #: com, edu, uk, gov, de, ca, mil, au, org, net

---

## 1995

>> NSFNET reverts back to a research network. Main US backbone traffic now routed through interconnected network providers

---

>> The new NSFNET is born as NSF establishes the very high speed Backbone Network Service (vBNS) linking super-computing centers: NCAR, NCSA, SDSC, CTC, PSC

---

>> Hong Kong police disconnect all but 1 of the colony's Internet providers in search of a hacker. 10,000 people are left without Net access.

---

>> Sun launches JAVA on May 23

---

>> RealAudio, an audio streaming technology, lets the Net hear in near real-time

---

>> Radio HK, the first commercial 24 hr., Internet-only radio station starts broadcasting

---

>> WWW surpasses ftp-data in March as the service with greatest traffic on NSFNet based on packet count, and in April based on byte count

---

>> Traditional online dial-up systems (CompuServe, America Online, Prodigy) begin to provide Internet access

---

>> Thousands in Minneapolis-St. Paul (USA) lose Net access after transients start a bonfire under a bridge at the Univ of MN causing fiber-optic cables to melt (30 July)

---

>> A number of Net related companies go public, with Netscape leading the pack with the 3rd largest ever NASDAQ IPO share value (9 August)

---

>> Registration of domain names is no longer free. Beginning 14 September, a \$50 annual fee has been imposed, which up until now was subsidized by NSF. NSF continues to pay for .edu registration, and on an interim basis for .gov

---

>> The Vatican comes on-line (<http://www.vatican.va/>)

---

>> The Canadian Government comes on-line (<http://canada.gc.ca/>)

---

>> The first official Internet wiretap was successful in helping the Secret Service and Drug Enforcement Agency (DEA) apprehend three individuals who were illegally manufacturing and selling cell phone cloning equipment and electronic devices

---

>> Operation Home Front connects, for the first time, soldiers in the field with their families back home via the Internet.

---

>> Richard White becomes the first person to be declared a munition, under the USA's arms export control laws, because of an RSA file security encryption program tattooed on his arm

---

RFC 1882: The 12-Days of Technology Before Christmas

---

>> Country domains registered: Ethiopia (ET), Cote d'Ivoire (CI), Cook Islands (CK) Cayman Islands (KY), Anguilla (AI), Gibraltar (GI), Vatican (VA), Kiribati (KI), Kyrgyzstan (KG), Madagascar (MG), Mauritius (MU), Micronesia (FM), Monaco (MC), Mongolia (MN), Nepal (NP), Nigeria (NG), Western Samoa (WS), San Marino (SM), Tanzania (TZ), Tonga (TO), Uganda (UG), Vanuatu (VU)

---

Top 10 Domains by Host #: com, edu, net, gov, mil, org, de, uk, ca, au

---

*Technologies of the Year:* WWW, Search engines

---

*Emerging Technologies:* Mobile code (JAVA, JavaScript), Virtual environments (VRML), Collaborative tools

---

## 1996

>> Internet phones catch the attention of US telecommunication companies who ask the US Congress to ban the technology (which has been around for years)

---

>> Malaysian Prime Minister Mahathir Mohamad, PLO Leader Yasser Arafat, and Phillipine President Fidel Ramos meet for ten minutes in an online interactive chat session on 17 January.

---

>> The controversial US Communications Decency Act (CDA) becomes law in the US in order to prohibit distribution of indecent materials over the Net. A few months later a three-judge panel imposes an injunction against its enforcement. Supreme Court unanimously rules most of it unconstitutional in 1997.

---

>> 9,272 organizations find themselves unlisted after the InterNIC drops their name service as a result of not having paid their domain name fee

---

>> Various ISPs suffer extended service outages, bringing into question whether they will be able to handle the growing number of users. AOL (19 hours), Netcom (13 hours), AT&T WorldNet (28 hours - email only)

---

>> Domain name tv.com sold to CNET for US\$15,000

---

>> New York's Public Access Networks Corp (PANIX) is shut down after repeated SYN attacks by a cracker using methods outlined in a hacker magazine ([2600](#))

---

>> MCI upgrades Internet backbone adding ~13,000 ports, bringing the effective speed from 155Mbps to 622Mbps.

---

>> The [Internet Ad Hoc Committee](#) announces plans to add 7 new generic Top Level Domains (gTLD): .firm, .store, .web, .arts, .rec, .info, .nom. The IAHC plan also calls for a competing group of domain registrars worldwide.

---

>> A malicious cancelbot is released on USENET wiping out more than 25,000 messages

---

>> The WWW browser war, fought primarily between Netscape and Microsoft, has rushed in a new age in software development, whereby new releases are made quarterly with the help of Internet users eager to test upcoming (beta) versions.

RFC 1925: [The Twelve Networking Truths](#)

---

>> Restrictions on Internet use around the world:

- *China:* requires users and ISPs to register with the police
- *Germany:* cuts off access to some newsgroups carried on CompuServe
- *Saudi Arabia:* confines Internet access to universities and hospitals
- *Singapore:* requires political and religious content providers to register with the state
- *New Zealand:* classifies computer disks as "publications" that can be censored and seized
- *source: Human Rights Watch*  
vBNS additions: Baylor College of Medicine, Georgia Tech, Iowa State Univ, Ohio State Univ, Old Dominion Univ, Univ of CA, Univ of CO, Univ of Chicago, Univ of IL, Univ of MN, Univ of PA, Univ of TX, Rice Univ  
Country domains registered: Qatar (QA), Central African Republic (CF), Oman (OM), Norfolk Island (NF), Tuvalu (TV), French Polynesia (PF), Syria (SY), Aruba (AW), Cambodia (KH), French Guiana (GF), Eritrea (ER), Cape Verde (CV), Burundi (BI), Benin (BJ) Bosnia-Herzegovina (BA), Andorra (AD), Guadeloupe (GP), Guernsey (GG), Isle of Man (IM), Jersey (JE), Lao (LA), Maldives (MV), Marshall Islands (MH), Mauritania (MR), Northern Mariana Islands (MP), Rwanda (RW), Togo (TG), Yemen (YE), Zaire (ZR)

---

Top 10 Domains by Host #: com, edu, net, uk, de, jp, us, mil, ca, au

---

*Hacks of the Year:* US Dept of Justice (17 Aug), CIA (19 Sep), Air Force (29 Dec), UK Labour Party (6 Dec)

---

*Technologies of the Year:* Search engines, JAVA, Internet Phone

---

*Emerging Technologies:* Virtual environments (VRML), Collaborative tools, Internet appliance (Network Computer)

---

## 1997

>> [2000th RFC](#): "Internet Official Protocol Standards"

---

>> 71,618 mailing lists registered at [Liszt](#), a mailing list directory

---

>> The [American Registry for Internet Numbers \(ARIN\)](#) is established to handle administration and registration of IP numbers to the geographical areas currently handled by Network Solutions (InterNIC), starting March 1998.

---

>> CA\*net II launched in June to provide Canada's next generation Internet using ATM/SONET

---

>> In protest of the DNS monopoly, AlterNIC's owner, Eugene Kashpureff, hacks DNS so users going to www.internic.net end up at www.alternic.net

---

>> Domain name business.com sold for US\$150,000

---

>> Early in the morning of 17 July, human error at Network Solutions causes the DNS table for .com and .net domains to become corrupted, making millions of systems unreachable.

---

>> Longest hostname registered with InterNIC:CHALLENGER.MED.SYNAPSE.UAH.UALBERTA.CA

---

>> 101,803 Name Servers in whois database

RFC 2100: [The Naming of Hosts](#)

Country domains registered: Falkland Islands (FK), East Timor (TP), R of Congo (CG), Christmas Island (CX), Gambia (GM), Guinea-Bissau (GW), Haiti (HT), Iraq (IQ), Lybia (LY), Malawi (MW), Martinique (MQ), Montserrat (MS), Myanmar (MM), French Reunion Island (RE), Seychelles (SC), Sierra Leone (SL), Somalia (SO), Sudan (SD), Tajkistan (TJ), Turkmenistan (TM), Turks and Caicos Islands (TC), British Virgin Islands (VG), Heard and McDonald Islands (HM), French Southern Territories (TF), British Indian Ocean Territory (IO), Scalbard and Jan Mayen Islands (SJ), St Pierre and Miquelon (PM), St Helena (SH), South Georgia/Sandwich Islands (GS), Sao Tome and Principe (ST), Ascension Island (AC), Tajikstan (TJ), US Minor Outlying Islands (UM), Mayotte (YT), Wallis and Futuna Islands (WF), Tokelau Islands (TK), Chad Republic (TD), Afghanistan (AF), Cocos Island (CC), Bouvet Island (BV), Liberia (LR), American Samoa (AS), Niue (NU), Equatorial New Guinea (GQ), Bhutan (BT), Pitcairn Island (PN), Palau (PW), DR of Congo (CD),

---

Top 10 Domains by Host #: com, edu, net, jp, uk, de, us, au, ca, mil

---

*Hacks of the Year:* Indonesian Govt (19 Jan, 10 Feb, 24 Apr, 30 Jun, 22 Nov), NASA (5 Mar), UK Conservative Party (27 Apr), Spice Girls (14 Nov)

---

*Technologies of the Year:* Push, Multicasting

---

*Emerging Technologies:* Push, Streaming Media

---

## 1998

>> *Hobbes' Internet Timeline* is released as [RFC 2235](#) & FYI 32

---

>> US Depart of Commerce (DoC) releases the [Green Paper](#) outlining its plan to privatize DNS on 30 January. This is followed up by a [White Paper](#) on June 5

Web size estimates range between 275 (Digital) and 320 (NEC) million pages

for 1Q

>> Companies flock to the Turkmenistan NIC in order to register their name under the .tm domain, the English abbreviation for trademark

>> Internet users get to be judges in a performance by 12 world champion ice skaters on 27 March, marking the first time a television sport show's outcome is determined by its viewers.

>> Network Solutions registers its 2 millionth domain on 4 May

>> Electronic postal stamps become a reality, with the [US Postal Service](#) allowing stamps to be purchased and downloaded for printing from the Web.

>> Canada kicks off CA\*net 3, the first national optical internet

>> CDA II and a ban on Net taxes are signed into US law (21 October)

>> ABCNews.com accidentally posts test US election returns one day early (2 November)

>> Indian ISP market is deregulated in November causing a rush for ISP operation licenses

>> US DoC enters into an [agreement](#) with the [Internet Corporation for Assigned Numbers \(ICANN\)](#) to establish a process for transitioning DNS from US Government management to industry (25 November)

>> San Francisco sites without off-city mirrors go offline as the city blacks out on 8 December

>> Chinese government puts Lin Hai on trial for "inciting the overthrow of state power" for providing 30,000 email addresses to a US Internet magazine (December) [ He is later sentenced to two years in jail ]

>> French Internet users give up their access on 13 December to boycott France Telecom's local phone charges (which are in addition to the ISP charge)

>> Open source software comes of age

RFC 2321: [RITA -- The Reliable Internetwork Troubleshooting Agent](#)

RFC 2322: [Management of IP numbers by peg-dhcp](#)

RFC 2323: [IETF Identification and Security Guidelines](#)

RFC 2324: [Hyper Text Coffee Pot Control Protocol \(HTCPCP/1.0\)](#)

Country domains registered: Nauru (NR), Comoros (KM)

*Bandwidth Generators:* Winter Olympics (Feb), World Cup (Jun-Jul), Starr Report (11 Sep), Glenn space launch

Top 10 Domains by Host #: com, net, edu, mil, jp, us, uk ,de, ca, au

*Hacks of the Year:* US Dept of Commerce (20 Feb), New York Times (13 Sep), China Society for Human Rights Studies (26 Oct), UNICEF (7 Jan)

*Technologies of the Year:* E-Commerce, E-Auctions, Portals

*Emerging Technologies:* E-Trade, XML, Intrusion Detection

## 1999

>> Internet access becomes available to the Saudi Arabian public in January

>> [First Internet Bank of Indiana](#), the first full-service bank available only on the Net, opens for business on 22 February

>> IBM becomes the first Corporate partner to be approved for Internet2 access

---

>> European Parliament proposes banning the caching of Web pages by ISPs

---

>> US State Court rules that domain names are property that may be garnished(扣押債務人的財產)

---

>> MCI/Worldcom, the vBNS provider for NSF, begins upgrading the US backbone to 2.5GBps

---

>> A forged Web page made to look like a Bloomberg financial news story raised shares of a small technology company by 31% on 7 April.

---

>> First large-scale Cyberwar takes place simulatenously with the war in Serbia/Kosovo

---

>> Abilene, the Internet2 network, reaches across the Atlantic and connects to NORDUnet and SURFnet

---

>> The Web becomes the focal point of British politics as a list of MI6 agents is released on a UK Web site. Though forced to remove the list from the site, it was too late as the list had already been replicated across the Net. (15 May)

---

>> [SETI@Home](#) project launches 17 May. The first attempt at making use of the large number of computers hooked to the Net that are constantly idle

---

>> Activists Net-wide target the world's financial centers on 18 June, timed to coincide with the G8 Summit. Little actual impact is reported.

---

>> ISOC approves the formation of the Internet Societal Task Force (ISTF). Vint Cerf serves as first chair

---

>> Free computers are all the rage (as long as you sign a long term contract for Net service)

---

RFC 2549: [IP over Avian Carriers with Quality of Service](#)

---

RFC 2550: [Y10K and Beyond](#)

---

RFC 2551: [The Roman Standards Process -- Revision III](#)

---

RFC 2555: [30 Years of RFCs](#)

---

Top 10 TLDs by Host #: com, net, edu, jp, uk, mil, us, de, ca, au

---

*Hacks of the Year:* Star Wars (8 Jan), .tp (Jan), USIA (23 Jan), E-Bay (13 Mar), US Senate (27 May), NSI (2 Jul), Paraguay Gov't (20 Jul), AntiOnline (5 Aug)

---

*Technologies of the Year:* E-Trade, Online Banking

---

*Virii of the Year:* [Melissa](#) (March), [ExploreZip](#) (June)

---

## 2000

>>The US timekeeper ([USNO](#)) and a few other time services around the world report the new year as 19100 on 1 Jan

---

>>A massive denial of service attack is launched against major web sites, including Yahoo, Amazon, and eBay in early February

---

>>Web size estimates by NEC-RI and Inktomi surpass 1 billion indexable pages

---

>>ICANN relegates the .pn domain, returning it to the Pitcairn Island community (Southern Pacific by British February)



Community (Society) Home by English, February

---

>>Internet2 backbone network deploys IPv6 (16 May)

---

>>Various domain name hijackings took place in late May and early June, including internet.com, bali.com, and web.net

---

>>A testbed allowing the registration of domain names in Chinese, Japanese, and Korean begins operation on 9 November. This testbed, created by VeriSign without IETF authorization, only allows the second-level domain to be non-English, still forcing use of .com, .net, .org. The Chinese government blocks internal registrations, stating that registrations in Chinese are its sovereignty right

---

>>ICANN selects new TLDs: .aero, .biz, .coop, .info, .museum, .name, .pro (16 Nov)

---

>>Mexico's connection to Internet2 becomes fully operational as the California research network (CalREN-2) is connected with Mexico's Corporación Universitaria para el Desarrollo de Internet (CUDI) network. Though connected in November, the link's inauguration by California's Governor and Mexico's President was not until March of 2001.

---

>>After months of legal proceedings, the French court rules Yahoo! must block French users from accessing hate memorabilia in its auction site (Nov). Given its inability to provide such a block on the Internet, Yahoo! removes those auctions entirely (Jan 2001). The case is eventually thrown out (Feb 2003).

---

>>The European Commission contracts with a consortium of 30 national research networks for the development of Géant, Europe's new gigabit research network meant to enhance the current capability provided by TEN-155 (6 Nov)

---

>>Australian government endorses the transfer of authority for the .au domain to auDA (18 Dec). ICANN signs over control to auDA on 26 Oct 2001.

---

RFC 2795: [The Infinite Monkey Protocol Suite](#)

---

*Hacks of the Year:* RSA Security (Feb), Apache (May), Western Union (Sep), Microsoft (Oct)

---

*Technologies of the Year:* ASP, Napster

---

*Emerging Technologies:* Wireless devices, IPv6

---

*Viruses of the Year:* [Love Letter](#) (May)

---

*Lawsuits of the Year:* Napster, DeCSS

---

## 2001

>>The first live distributed musical -- *The Technophobe & The Madman* -- over Internet2 networks debuts on 20 Feb

---

>>VeriSign extends its multilingual domain testbed to encompass various European languages (26 Feb), and later the full Unicode character set (5 Apr) opening up most of the world's languages

---

>>Forwarding email in Australia becomes illegal with the passing of the Digital Agenda Act, as it is seen as a technical infringement of personal copyright (4 Mar)

---

>>Radio stations broadcasting over the Web go silent over actor royalty disputes (10 Apr)

---

>>High schools in five states (Michigan, Missouri, Oregon, Virginia, and Washington) become the first to gain Internet2 access  
SETI@Home launches on 17 May and within four weeks its distributed Internet clients provide more computing power than the most powerful

supercomputer of its time (:par:)

---

>>US Dept of Commerce issues a notice of intent on 6 April to turn over management for the .edu domain from VeriSign to [Educause](#). Award agreement is reached on 29 October. Community colleges will finally be able to register under .edu

---

>>Napster keeps finding itself embroiled in litigation and is eventually forced to suspend service; it comes back later in the year as a subscription service

---

>>European Council finalizes an international cybercrime treaty on 22 June and adopts it on 9 November. This is the first treaty addressing criminal offenses committed over the Internet.

---

>>.biz and .info are added to the root server on 27 June with registrations beginning in July. .biz domain go live on 7 Nov.

---

>>Afghanistan's Taliban bans Internet access country-wide, including from Government offices, in an attempt to control content (13 Jul)

---

>>Code Red worm and Sircam virus infiltrate thousands of web servers and email accounts, respectively, causing a spike in Internet bandwidth usage and security breaches (July)

---

>>A fire in a train tunnel running through Baltimore, Maryland seriously damages various fiber-optic cable bundles used by backbone providers, disrupting Internet traffic in the Mid-Atlantic states and creating a ripple effect across the US (18 Jul)

---

>>Brazil RNP2 is connected to Internet2's Abilene over 45Mbps line (21 Aug)

---

>>[GÉANT](#), the pan-European Gigabit Research and Education Network, becomes operational (23 Oct), replacing the TEN-155 network which was closed down (30 Nov)

---

>>.museum begins resolving (Nov)

---

>>First uncompressed real-time gigabit HDTV transmission across a wide-area IP network takes place on Internet2 (12 Nov).

---

>>Dutch SURFnet and Internet2's Abilene connect via gigabit ethernet (15 Nov)

---

>>.us domain operational responsibility assumed by NeuStar (20 Nov)

---

RFC 3091: [Pi Digit Generation Protocol](#)

---

RFC 3092: [Etymology of "Foo"](#)

---

RFC 3093: [Firewall Enhancement Protocol \(FEP\)](#)

---

*Viruses of the Year*: Code Red (Jul), Nimda (Sep), SirCam (Jul), BadTrans (Apr, Nov)

---

*Emerging Technologies*: Grid Computing, P2P

---

## 2002

>>US ISP Association (USISPA) is created from the former CIX (11 Jan)

---

>>.name begins resolving (15 Jan)

---

>>.coop registrations begin (30 Jan)

---

>>Global Terabit Research Network ([GTRN](#)) is formed composed of two OC-48 2.4GB circuits connecting Internet2 Abilene, CANARIE CA\*net3, and GÉANT (18 Feb)

---

>>.aero registrations begin 18 March and begins resolving 2 Sept.

---

>> Federally recognized US Indian tribes become eligible to register under .gov (26 Apr)

---

>> Hundreds of Internet radio stations observe a *Day of Silence* in protest of proposed song royalty rate increases (1 May)

---

>> Abilene (Internet2) backbone deploys native IPv6 (5 Aug)

---

>> The 69/8 IP range is allocated to ARIN in August after having been in the [bogon](#) list; users and servers assigned a 69/8 address find themselves blocked from many Internet sites

---

>> Internet2 now has 200 university, 60 corporate, and 40 affiliate members (2 Sep)

---

>> Having your own **Blog** becomes hip

---

>> Hundreds of Spain-based web sites take their content offline in protest of a new law that took effect on 12 Oct requiring all commercial Web sites to register with the government

---

>> A distributed denial of service (DDoS) attack struck the 13 DNS root servers knocking out all but 5 (21-23 Oct). Amidst national security concerns, VeriSign hastens a planned relocation of one of its two DNS root servers

---

>> A new US law creates a kids-safe "dot-kids" domain (kids.us) to be implemented in 2003 (3 Dec)

---

>> The FBI teams up with Terras Lycos to disseminate virtual wanted posts across the Web portal's properties (11 Dec)

---

RFC 3251: [Electricity over IP](#)

---

RFC 3252: [Binary Lexical Octet Ad-hoc Transport](#)

---

## 2003

>> Public Interest Registry (PIR) takes over as .org registry operator on 1 Jan. By giving up .org, VeriSign is able to retain control over .com domains

---

>> The first official Swiss online election takes place in Anières (7 Jan)

---

>> The registration for domain ogrish.com is deleted (11 Jan) by the German registrar Joker.com at the request of a German prosecutor claiming objectionable content; the site however is hosted in the United States and complies with US laws.

---

>> The **SQL Slammer worm** causes one of the largest and fastest spreading DDoS attacks ever. Taking roughly 10 minutes to spread worldwide, the worm took down 5 of the 13 DNS root servers along with tens of thousands of other servers, and impacted a multitude of systems ranging from (bank) ATM systems to air traffic control to emergency (911) systems (25 Jan). This is followed in August by the Sobig.F virus (19 Aug), the fastest spreading virus ever, and the Blaster (MSBlast) worm (11 Aug), another one of the most destructive worms ever

---

>> [.nl](#) registrations open up to anyone, including individuals and foreigners (29 Jan); [.se](#) also opens up its registration in April. [.af](#) is [re delegated](#) on 8 Jan and becomes live once again on 12 Feb with UNDP technical assistance. First domains are moc.gov.af and undp.org.af (15 Feb)

---

>> **Flash mobs**, organized over the Net, start in New York and quickly form in cities worldwide

---

>> Taxes make headlines as: larger US Internet retailers begin collecting taxes on all purchases; some US states tax Internet bandwidth; and the EU requires all Internet companies to collect value added tax (VAT) on digital downloads

---

starting 1 July

---

>>The French Ministry of Culture bans the use of the word "e-mail" by government ministries, and adopts the use of the more French sounding "courriel" (Jul)

---

>>.kids.us sunrise registration begins 17 June and public registration on 9 Sep

---

>>The Recording Industry Association of America (RIAA) sues 261 individuals on 8 Sep for allegedly distributing copyright music files over peer-to-peer networks

---

>>VeriSign deploys a wildcard service (Site Finder) into the .com and .net TLDs causing much confusion as URLs with invalid domains are redirected to a VeriSign page (15 Sep). ICANN orders VeriSign to stop the service, which they comply with on 4 Oct  
Last Abilene segment upgraded to 10Gbps (5 Nov)

---

>>[Little GLORIAD](#) (Global Ring Network for Advanced Application Development) starts operations (22 Dec), consisting of a networked ring across the northern hemisphere with connections in Chicago, Amsterdam, Moscow, Novosibirsk, Zabajkal'sk, Manzhouli, Beijing, and Hong Kong. This is the first-ever fiber network connections across the Russia-China border

---

RFC 3514: [The Security Flag in the IPv4 Header](#) (The Evil Bit)

## 2004

---

>>For the first time, there are more instances of DNS root servers outside the US with the launch of an anycast instance of the RIPE NCC operated [K-root server](#)

---

>>Abilene, the Internet2 backbone, upgrade from 2.5Gbps to 10Gbps is completed (4 Feb)

---

>>Network Solutions begins offering 100 year domain registration (24 Mar)

---

>>VeriSign Naming and Directory Service (VNDS) begins updating all 13 .com/.net authoritative name servers in near real-time vs. twice each day (8 Sep)

---

>>Lycos Europe releases a screen saver to help fight spam by keeping spam servers busy with requests (1 Dec). The service is discontinued within a few days after backbone providers block access to the download site and the service causes some servers to crash.

---

>>CERNET2, the first backbone IPv6 network in China, is launched by the China Education and Research Network (CERN) connecting 25 universities in 20 cities at speeds of 1-10Gbps (27 Dec)

**2003.** The SQL Slammer worm spread worldwide in just 10 minutes. Myspace, Skype and the Safari Web browser debut.

**2004:** Facebook goes online and the era of social networking begins. Mozilla unveils the Mozilla Firefox browser.

**2005:** YouTube.com launches.

**2006:** AOL changes its business model, offering most services for free and relying on advertising to generate revenue. The Internet Governance Forum meets for the first time.

**2009:** The Internet marks its 40th anniversary.

**2010:** Facebook reaches 400 million active users.

**2011:** Twitter and Facebook play a large role in the Middle East revolts.

**Growth**

Internet | Networks | WWW | USENET | Security

**Internet growth:**

Date	Hosts		Date	Hosts	Networks	Domains
----	-----	+	----	-----	-----	-----
12/69	4		07/89	130,000	650	3,900
06/70	9		10/89	159,000	837	
10/70	11		10/90	313,000	2,063	9,300
12/70	13		01/91	376,000	2,338	
04/71	23		07/91	535,000	3,086	16,000
10/72	31		10/91	617,000	3,556	18,000
01/73	35		01/92	727,000	4,526	
06/74	62		04/92	890,000	5,291	20,000
03/77	111		07/92	992,000	6,569	16,300
12/79	188		10/92	1,136,000	7,505	18,100
08/81	213		01/93	1,313,000	8,258	21,000
05/82	235		04/93	1,486,000	9,722	22,000
08/83	562		07/93	1,776,000	13,767	26,000
10/84	1,024		10/93	2,056,000	16,533	28,000
10/85	1,961		01/94	2,217,000	20,539	30,000
02/86	2,308		07/94	3,212,000	25,210	46,000
11/86	5,089		10/94	3,864,000	37,022	56,000
12/87	28,174		01/95	4,852,000	39,410	71,000
07/88	33,000		07/95	6,642,000	61,538	120,000
10/88	56,000		01/96	9,472,000	93,671	240,000
01/89	80,000		07/96	12,881,000	134,365	488,000
			01/97	16,146,000		828,000
			07/97	19,540,000		1,301,000

\*\*\* see Note below \*\*\*

Hosts = a computer system with registered ip address (an A record)  
 Networks = registered class A/B/C addresses  
 Domains = registered domain name (with name server record)

Note: A more accurate survey mechanism was developed in 1/98; new and some corrected numbers are shown below. For further info, see [Sources section](#).

Date	Hosts		Date	Hosts		Date	Hosts
----	-----	+	----	-----	+	----	-----
01/95	5,846,000		07/98	36,739,000		01/02	147,344,723
07/95	8,200,000		01/99	43,230,000		07/02	162,128,493
01/96	14,352,000		07/99	56,218,000		01/03	171,638,297
07/96	16,729,000		01/00	72,398,092		01/04	233,101,481
01/97	21,819,000		07/00	93,047,785		07/04	285,139,107
07/97	26,053,000		01/01	109,574,429		01/05	317,646,084
01/98	29,670,000		07/01	125,888,197		07/05	353,284,187

**Figure: Internet Hosts**

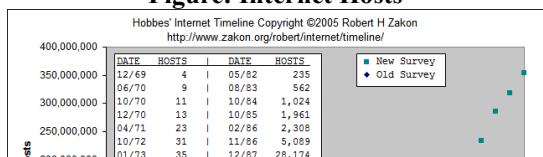

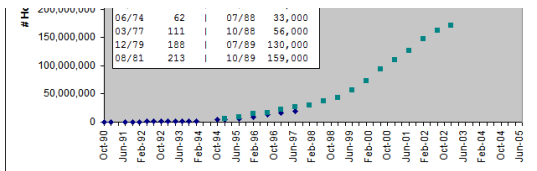

[click here for a chart showing the logarithmic growth of the Internet](#)

**Figure: Internet Domains**

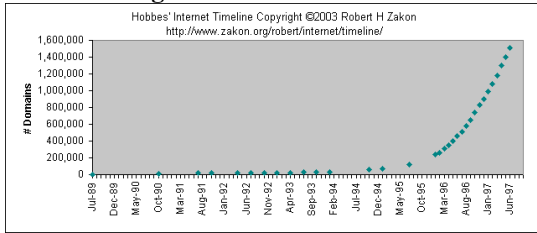

**Figure: Internet Networks**

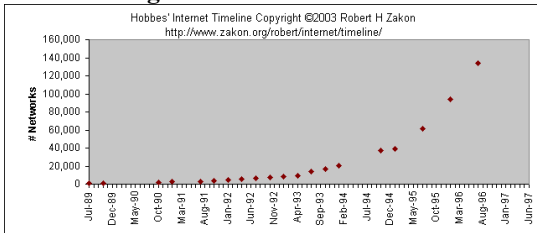

**Worldwide Networks Growth: (I)Internet (B)ITNET (U)UCP (F)IDONET (O)SI**

Date	# Countries					Date	# Countries				
	I	B	U	F	O		I	B	U	F	O
09/91	31	47	79	49		02/94	62	51	125	88	31
12/91	33	46	78	53		07/94	75	52	129	89	31
02/92	38	46	92	63		11/94	81	51	133	95	--
04/92	40	47	90	66	25	02/95	86	48	141	98	--
08/92	49	46	89	67	26	06/95	96	47	144	99	--
01/93	50	50	101	72	31	06/96	134	--	146	108	--
04/93	56	51	107	79	31	07/97	171	--	147	108	--
08/93	59	51	117	84	31						

**Figure: Worldwide Networks Growth**

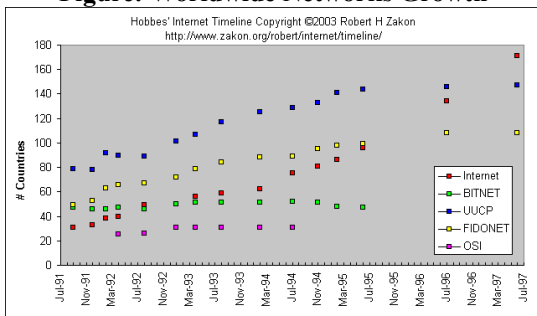

**WWW Growth:**

12/90	1	09/98	3,156,324	02/02	38,444,856
12/91	10	10/98	3,358,969	03/02	38,118,962
12/92	50	11/98	3,518,158	04/02	37,585,233
06/93	130	12/98	3,689,227	05/02	37,574,105
09/93	204	01/99	4,062,280	06/02	38,807,788
10/93	228	02/99	4,301,512	07/02	37,235,470
12/93	623	03/99	4,349,131	08/02	35,991,815
06/94	2,738	04/99	5,040,663	09/02	35,756,436
12/94	10,022	05/99	5,414,325	10/02	35,114,328
06/95	23,500	06/99	6,177,453	11/02	35,686,907
01/96	100,000	07/99	6,598,697	12/02	35,543,105
03/96	135,396	08/99	7,078,194	01/03	35,424,956
04/96	150,295	09/99	7,370,929	02/03	35,863,952

05/96	193,150		10/99	8,115,828		03/03	39,174,349
06/96	252,000		11/99	8,844,573		04/03	40,100,739
07/96	299,403		12/99	9,560,866		05/03	40,444,778
08/96	342,081		01/00	9,950,491		06/03	40,936,076
09/96	397,281		02/00	11,161,811		07/03	42,298,371
10/96	462,047		03/00	13,106,190		08/03	42,807,275
11/96	525,906		04/00	14,322,950		09/03	43,144,374
12/96	603,367		05/00	15,049,382		10/03	43,700,759
01/97	646,162		06/00	17,119,262		11/03	44,946,965
02/97	739,688		07/00	18,169,498		12/03	45,980,112
03/97	883,149		08/00	19,823,296		01/04	46,067,743
04/97	1,002,612		09/00	21,166,912		02/04	47,173,415
05/97	1,044,163		10/00	22,282,727		03/04	48,038,131
06/97	1,117,259		11/00	23,777,446		04/04	49,750,568
07/97	1,203,096		12/00	25,675,581		05/04	50,550,965
08/97	1,269,800		01/01	27,585,719		06/04	51,635,284
09/97	1,364,714		02/01	28,125,284		07/04	52,131,889
10/97	1,466,906		03/01	28,611,177		08/04	53,341,867
11/97	1,553,998		04/01	28,669,939		09/04	54,407,216
12/97	1,681,868		05/01	29,031,745		10/04	55,388,466
01/98	1,834,710		06/01	29,302,656		11/04	56,115,015
02/98	1,920,933		07/01	31,299,592		12/04	56,923,737
03/98	2,084,473		08/01	30,775,624		01/05	58,194,836
04/98	2,215,195		09/01	32,398,046		02/05	59,100,880
05/98	2,308,502		10/01	33,135,768		03/05	60,442,655
06/98	2,410,067		11/01	36,458,394		04/05	62,286,451
07/98	2,594,622		12/01	36,276,252		05/05	63,532,742
08/98	2,807,588		01/02	36,689,008		06/05	64,808,485
						07/05	67,571,581
						08/05	70,392,567

Sites = # of web servers (one host may have multiple sites by using different domains or port numbers)

Figure: WWW Growth

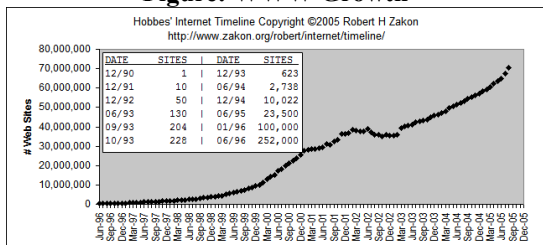

[click here for a chart showing the logarithmic growth of the Web](#)

**USENET Growth:**

Date	Sites	~MB	~Posts	Groups		Date	Sites	~MB	~Posts	Groups
1979	3		2	3	+	1987	5,200	2	957	259
1980	15		10			1988	7,800	4	1933	381
1981	150	0.05	20			1990	33,000	10	4,500	1,300
1982	400		35			1991	40,000	25	10,000	1,851
1983	600		120			1992	63,000	42	17,556	4,302
1984	900		225			1993	110,000	70	32,325	8,279
1985	1,300	1.0	375			1994	180,000	157	72,755	10,696
1986	2,200	2.0	946	241		1995	330,000	586	131,614	

~ approximate: MB - megabytes per day, Posts - articles per day

**Security (CERT/US-CERT) Stats:**

Date	Incidents	Advisories	Vulnerabilities	Tech Alerts
1988	6		1	
1989	132		7	
1990	252		12	
1991	406		23	

1992	773	21	
1993	1,334	19	
1994	2,340	15	
1995	2,412	18	171
1996	2,573	27	345
1997	2,134	28	311
1998	3,734	13	262
1999	9,859	17	417
2000	21,756	22	774
2001	52,658	37	2,437
2002	82,094	37	4,129
2003	137,529	28	3,784
2004/1-3Q			2,683

22

### Hobbes' Internet Timeline FAQ

#### 1. How do I get Hobbes' Internet Timeline?

The Timeline is archived at <http://www.zakon.org/robert/internet/timeline/>.

There are no authorized mirrors for the Timeline.

#### 2. Is the Timeline available in other languages or editions?

- [Chinese \(Big5\)](#) by Tony Mao
- [Chinese \(GB\)](#) by Guo Li
- [French](#) by Didier Mainguy
- [German](#) by Michael Kaul
- [Italian](#) by Ivo Aceto
- [Japanese](#)
- [Korean](#) by Keonho Lee, KNIC
- [Persian / Farsi](#) (PDF) by Rahi Moosavi
- [Portuguese](#) by Simone Villas Boas
- [Russian](#) by Stanislav Korotygin
- [Spanish](#) by Pablo Ibarrolaza & Monica Piazza

If you are interested in translating to another language or format, email me first

#### 3. Can I re-print the Timeline or use parts of it for ... ?

Drop me an email. The answer is most likely (though don't assume) 'yes' for non-profit use, and 'maybe' for for-profit; but to be sure you are not going to break any copyright laws, drop me an email and wait for a reply. Also, please note that I get a bunch of requests with improperly formatted return email addresses. If you don't hear from me in a week (typical turn around is < 1 hour), check your header and email again. BTW, don't forget to tell me who you are, your affiliation and how you plans to use the Timeline; anonymous copyright requests will not be granted.

#### 4. What do you do when not updating the Timeline?

For fun: travel, photography, R/C boats, developing technology prototypes ranging from robots, speech to speech translators, and an assortment of Web capabilities and outdoor activities. Professionally: evangelize/research/develop advanced Internet, Web, e-commerce and multilingual computing technologies. Explore <http://www.zakon.org/> to learn more.

#### 0. Peddie (Ala Viva!), CWRU (North Side), Amici usque ad aras (PKP OH-EP), Colégio Andrews (Rio), Gordonstoun (Elgin)

E-mail me if you know

### Sources

Hobbes' Internet Timeline was compiled from a number of sources, with some of the stand-outs being:

Cerf, Vinton (as told to Bernard Aboba). "How the Internet Came to Be." This article appears in "The Online User's Encyclopedia," by Bernard Aboba. Addison-Wesley, 1993.

Hardy, Henry. "The History of the Net." Master's Thesis, School of Communications, Grand Valley State University.  
<http://www.vrx.net/usenet/history/hardy/>

Hardy, Ian. "The Evolution of ARPANET email." History Thesis, UC Berkeley.  
<http://www.ifla.org/documents/internet/haril.txt>



Hauben, Ronda and Michael. "The Netizens and the Wonderful World of the Net."  
<http://www.columbia.edu/~hauben/netbook/>

Kulikowski, Stan II. "A Timeline of Network History." (author's email below)

Quarterman, John. "[The Matrix: Computer Networks and Conferencing Systems Worldwide](#)." Bedford, MA: Digital Press. 1990

"ARPANET, the Defense Data Network, and Internet". Encyclopedia of Communications, Volume 1. Editors: Fritz Froehlich, Allen Kent. New York: Marcel Dekker, Inc. 1991

Internet growth summary compiled from:

- Zone program reports maintained by Mark Lottor at:  
<ftp://ftp.nw.com/pub/zone/>
- Note: A more accurate host counting mechanism was used starting with 1/98 count. Now available at: <http://www.isc.org/>
- Connectivity table maintained by Larry Landweber at:  
[ftp://ftp.cs.wisc.edu/connectivity\\_table/](ftp://ftp.cs.wisc.edu/connectivity_table/)
- ARPAnet maps published in various sources

WWW growth summary compiled from:

- Web growth summary page by Matthew Gray of MIT:  
<http://www.mit.edu/people/mkgray/net/web-growth-summary.html>
- Netcraft at <http://www.netcraft.com/survey/>

USENET growth summary compiled from Quarterman and Hauben sources above, and [news.lists](#) postings. Lots of historical USENET postings also provided by Tom Fitzgerald (fitz@wang.com).

CERT growth summary compiled from CERT reports at <ftp://ftp.cert.org/>  
 CERT stats are also now being made available by CERT at [http://www.cert.org/stats/cert\\_stats.html](http://www.cert.org/stats/cert_stats.html)

Many of the URLs provided by Arnaud Dufour (arnaud.dufour@hec.unil.ch)

Country-specific Internet Histories:

- Australia - "A Brief History of the Internet in Australia" by Roger Clarke  
<http://www.anu.edu.au/people/Roger.Clarke/II/OzIHist.html>
- Australia - "It Started with a Ping" by Jennie Sinclair  
<http://www.anu.edu.au/people/Roger.Clarke/II/Anniv.html>
- Brazil - "Linha to Tempo da Internet no Brasil" by Érico Guizzo  
<http://www.ciberespaco.com.br/inetbr/>
- Finland - "History of the Internet in Finland"  
[http://www.isoc.fi/internet/internethistory\\_finland.html](http://www.isoc.fi/internet/internethistory_finland.html)
- South Africa - "The History of the Internet in South Africa - How it began"  
<http://www2.frd.ac.za/uninet/history/>
- UK - "Early Experiences with the ARPANET and INTERNET in the UK" by Peter Kirstein  
<http://www.cs.ucl.ac.uk/staff/jon/arpa/internet-history.html>

Additional books of interest:

- "[How the Web Was Born - The Story of the World Wide Web](#)"  
 by James Gillies and Robert Cailliau
- "[Weaving the Web : The Original Design and Ultimate Destiny of the World Wide Web by its Inventor](#)"  
 by Tim Berners-Lee
- "[Where Wizards Stay Up Late: The Origins of the Internet](#)"  
 by Katie Hafner & Matthew Lyon
- "[Nerds 2.0.1: A Brief History of the Internet](#)"  
 by Stephen Segaller
- "[Architects of the Web: 1,000 Days That Built the Future of Business](#)"  
 by Robert H. Reid
- "[Netizens: On the History and Impact of Usenet and the Internet](#)"  
 by Michael Hauben et al
- "[Exploring the Internet: A Technical Travelogue](#)"  
 by Carl Malamud

Early works of interest:

- "As We May Think" by Vannevar Bush, 1945  
<http://www.theatlantic.com/unbound/flashbks/computer/bushf.htm>
- "Man-Computer Symbiosis" by J.C.R. Licklider, 1960  
<http://gatekeeper.dec.com/pub/DEC/SRC/research-reports/abstracts/src-rr-061.html>
- Assorted early documents  
[http://www.cs.utexas.edu/users/chris/think/digital\\_archive.html](http://www.cs.utexas.edu/users/chris/think/digital_archive.html)

---

Contributors to Hobbes' Internet Timeline have their initials next to the contributed items in the form (:zzz:) and are:

adl - Arnaud Dufour (arnaud.dufour @ hec.unil.ch)  
 amk - Alex McKenzie (mckenzie @ bbn.com)  
 bbl - Billy Brackenridge (billyb @ microsoft.com)  
 btl - Brad Templeton (btm @ templetons.com)  
 clg - C. Lee Giles (giles @ research.nj.nec.com)  
 dhr - David H. Rothman (davidrothman @ yahoo.com)  
 dkl - Daniel Karrenberg (Daniel.Karrenberg @ ripe.net)  
 ecl - Eric Carroll (eric @ enfm.utcc.utoronto.ca)  
 esr - Eric S. Raymond (esr @ locke.ccil.org)  
 feg - Farrell E. Gerbode (farrell @ is.rice.edu)  
 gbl - Gordon Bell (GBell @ microsoft.com)  
 gck - Gary C. Kessler (kumquat @ sover.net)  
 glg - Gail L. Grant (grant @ glgc.com)  
 gmc - Grant McCall (g.mccall @ unsw.edu.au)  
 gst - Graham Thomas (G.S.Thomas @ uel.ac.uk)  
 irh - Ian R Hardy (hardy @ uclink2.berkeley.edu)  
 jap - Jean Armour Polly (mom @ netmom.com)  
 jgl - Jim Gaynor (gaynor @ niherlas.com)  
 kfl - Ken Fockler (fockler @ hq.canet.ca)  
 kf2 - Kinming Fung (kinming @ cuhk.edu.hk)  
 lb1 - Larry Backman (backman @ ultranet.com)  
 lhl - Larry H. Landweber (lhl @ cs.wisc.edu)  
 mpc - Mellisa P. Chase (pc @ mitre.org)  
 msh - Michael S. Hart (hart @ pobox.com)  
 par - Pierre A Renaud (yendred @ videotron.ca)  
 pb1 - Paul Burchard (burchard @ cs.princeton.edu)  
 pds - Peter da Silva (peter @ baileynm.com)  
 ph1 - Peter Hoffman (hoffman @ ece.nps.navy.mil)  
 rab - Roger A. Bielefeld (rab @ hal.cwru.edu)  
 rml - Rahi Moosavi (info @ farsi-freelance.com)  
 scl - Susan Calcari (susanc @ is.internic.net)  
 sk2 - Stan Kulikowski (stankuli @ uwf.bitnet) - see sources section  
 sw1 - Stephen Wolff (swolff @ cisco.com)  
 tb1 - Tim Burress (tim @ twics.com)  
 tp1 - Tim Pozar (pozar @ kumr.lns.com)  
 vgc - Vinton Cerf (vcerf @ isoc.org) - see sources section  
 wz1 - W. Zorn (zorn @ ira.uka.de)  
 zby - Zenel Batagelj (zenel.batagelj @ uni-lj.si)

---

:-) :-) :-) :-) :-) :-) :-) ;-) **Help the Author** (-: (-: (-: (-: (-: (-: (-:

Thank you to the thousands of Net folks who contributed information to help the author's genealogical search, yielding 45 new Zakon's from around the world!

Archive-name: Hobbes' Internet Timeline

Version: 8.1

Archive-location: <http://www.zakon.org/robert/internet/timeline/>

Last-updated: 28 August 2005

Maintainer: Robert H'obbes' Zakon, [timeline@Zakon.org](mailto:timeline@Zakon.org), <http://www.zakon.org/>

Description:

An Internet timeline highlighting some of the key events and technologies that helped shape the Internet as we know it today.

---